

Sports formula

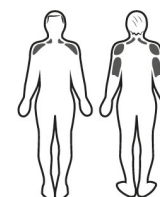

Muscular stimulation

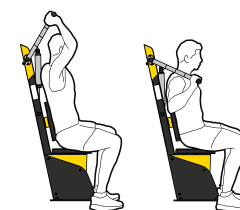

Movements

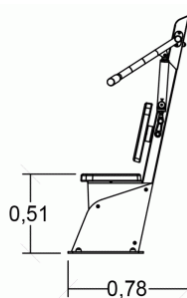
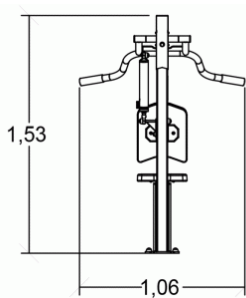

► **Sports activities :** 2

Resistance



x1

Soulever



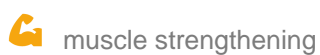

x1





## ► Installation of equipment

**IMPORTANT:** It is essential to refer to the installation instructions for information on the size of the safety areas.

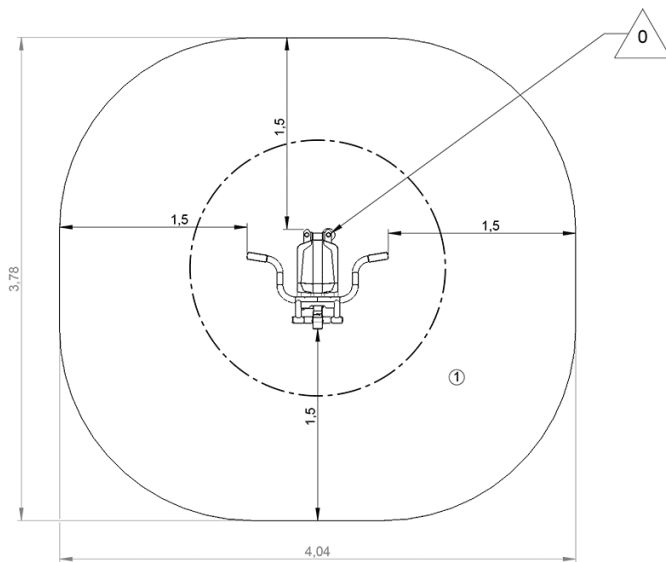
-  Impact area (minimum normative surface)
-  Free space



		
1	0,5m	13,34m <sup>2</sup>



2



02h00



0.14m<sup>3</sup>



13m<sup>2</sup>



60kg



22kg

